

Florence Bed

Assembly Instructions

For Double & King Bed

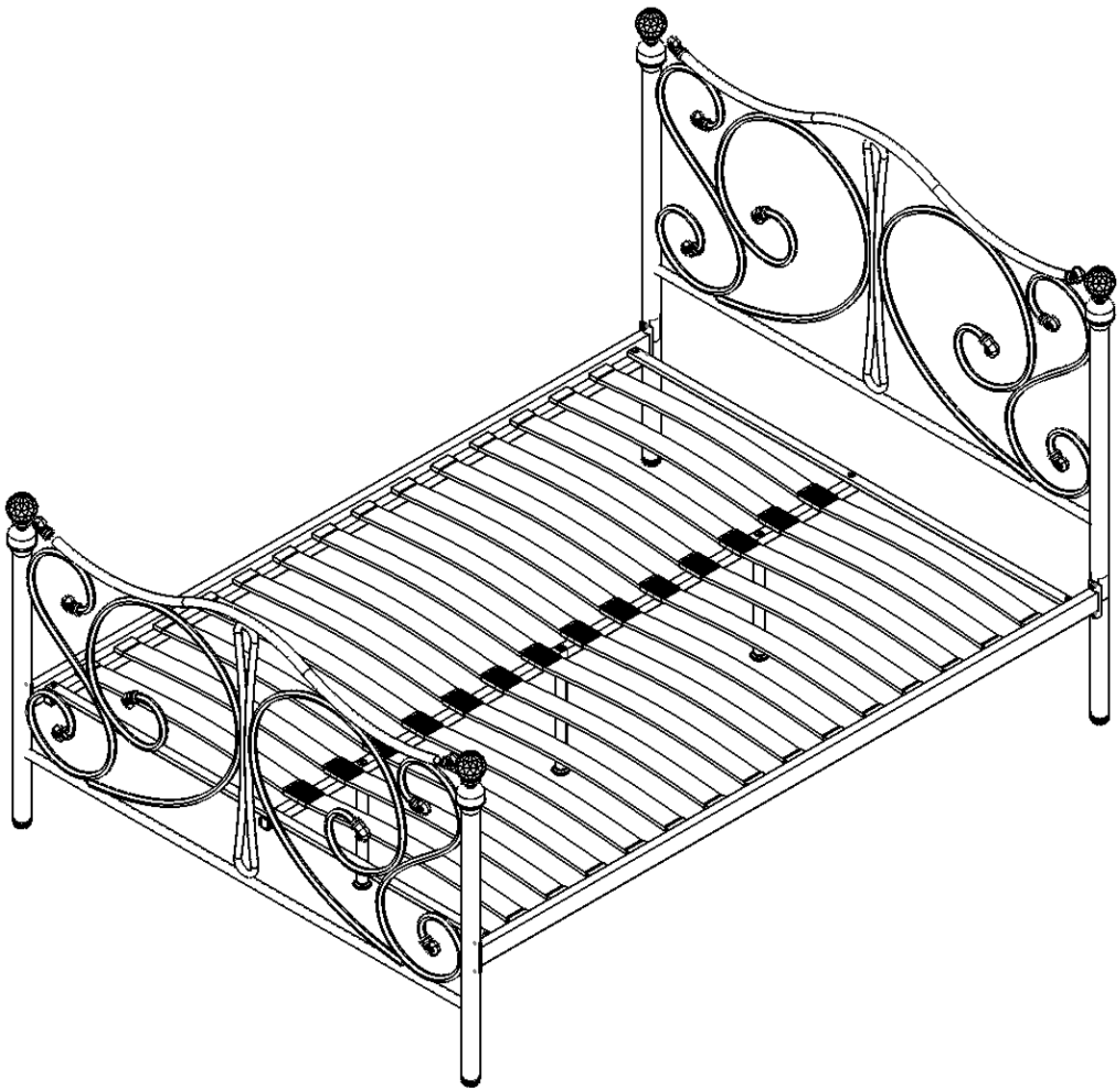

IMPORTANT - READ CAREFULLY - RETAIN THESE INSTRUCTIONS FOR FUTURE REFERENCE

- Due to the size of this product, we recommend that it is assembled in the room intended for use.
- When you are ready to start, make sure that you have the right tools, plenty of space and a clean, dry area for assembly.
- Unwrap all packaging materials and place the components on top to the carton box or on a clean blanket to prevent it and your floor from scratching.
- **PLEASE KEEP THE ORIGINAL PACKING UNTIL YOUR ITEM IS FULLY ASSEMBLED. IN THE UNLIKELY EVENT YOU NEED TO RETURN YOUR PRODUCT, IT MUST BE RETURNED IN ITS ORIGINAL PACKING, OTHERWISE NO RETURNS WILL BE ACCEPTED.**
- Keeping small parts in a bowl should reduce the chances of losing any small components.
- Check the pack and make sure you have all the parts listed.
- Ensure that the product is fully assembled and secured as illustrated before use.
- Check all screws or bolts are tightened and inspect regularly - this is a normal requirement of flat-pack furniture.
- This product should only be used on firm, level ground.
- Please dismantle fully before transporting anywhere.
- **IF THIS PRODUCT IS GOING TO BE USED ON A WOOD, LAMINATE OR TILED FLOOR, YOU MUST APPLY "ANTI SLIP PADS" TO ALL LEGS TOUCHING THE FLOOR. THESE ARE AVAILABLE TO BUY IN MOST HARDWARE SHOPS IN A FELT MATERIAL OR RUBBER AND ARE RELATIVELY INEXPENSIVE. THE PADS WILL PROTECT YOUR FLOOR FROM ANY MARKING AND ALSO FROM SLIPPING. FAILURE TO APPLY THE PADS WILL RESULT IN NO RETURNS OF THE PRODUCT AND ANY SPARE'S REQUESTED.**







WARNINGS

- This product is intended for a maximum person's weight of 75kg per side. Do not exceed this weight.
- Keep small parts out of reach of children, as they present a choking hazard.
- Make sure the legs remain in contact with the ground.
- Do not use power tools to construct this product. Only use those tools listed. The use of power tools will invalidate any future claim.
- Do not tighten screws fully until fully assembled, to ensure that the product is square.
- Do not use the product if parts are missing, damaged or worn.
- Do not stand directly on the product. Keep sharp or heavy objects away from the surface of the product.
- Incorrect installation could lead to injury. Take care following instructions.

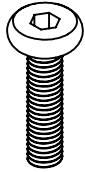
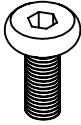
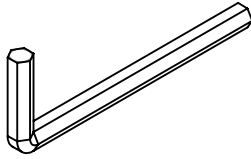
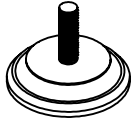
CARE INFORMATION

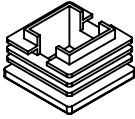
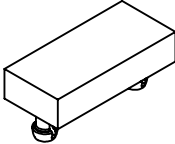
- Never use scourers, abrasives or chemical cleaners. Avoid contact with hair spray, nail polish or varnishes.
- To clean, wipe with a sponge and warm soapy water. Do not use solvent-based cleaners or detergents as they can bleach or damage the product.
- Once you are satisfied with your new product, please dispose of all packaging in a safe and environmentally friendly way.

FITTINGS

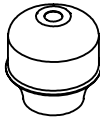
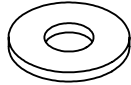
- | | | | |
|--|--|---|--|
| A
 | B
 | C
 | D
 |
| M6x25mm
x6 pcs | M6x15mm
x11 pcs | M4xAllen Key
x1 pcs | Centre Rail Foot
x3 pcs |
| E
 | F
 | G
 | H
 |
| Plastic Leg Caps
x4 pcs | Plastic End Caps
x6 pcs | Slat End Caps
x28 pcs Double
x30 pcs King | Slat Centre Caps
x14 pcs Double
x15 pcs King |
| I
 | J
 | K
 | L
 |
| Crystal Balls
x4 pcs | Non Cap Screws
x4 pcs | Crystal Ball Bases
x4 pcs | Flat Washer
x9 pcs |

COMPONENTS

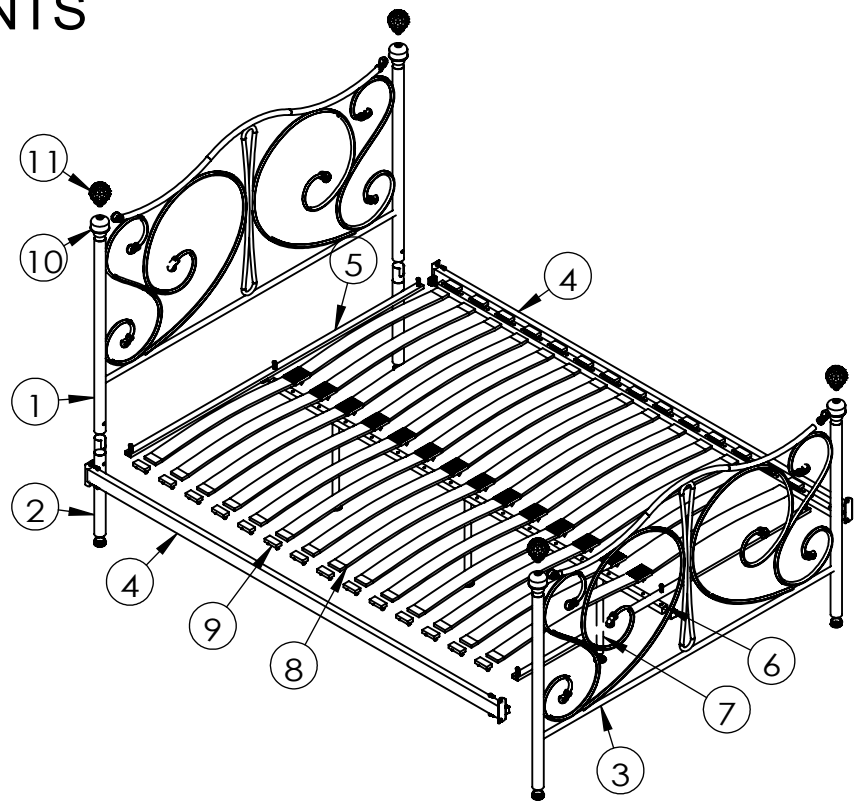

1

M6 x 15 8pcs

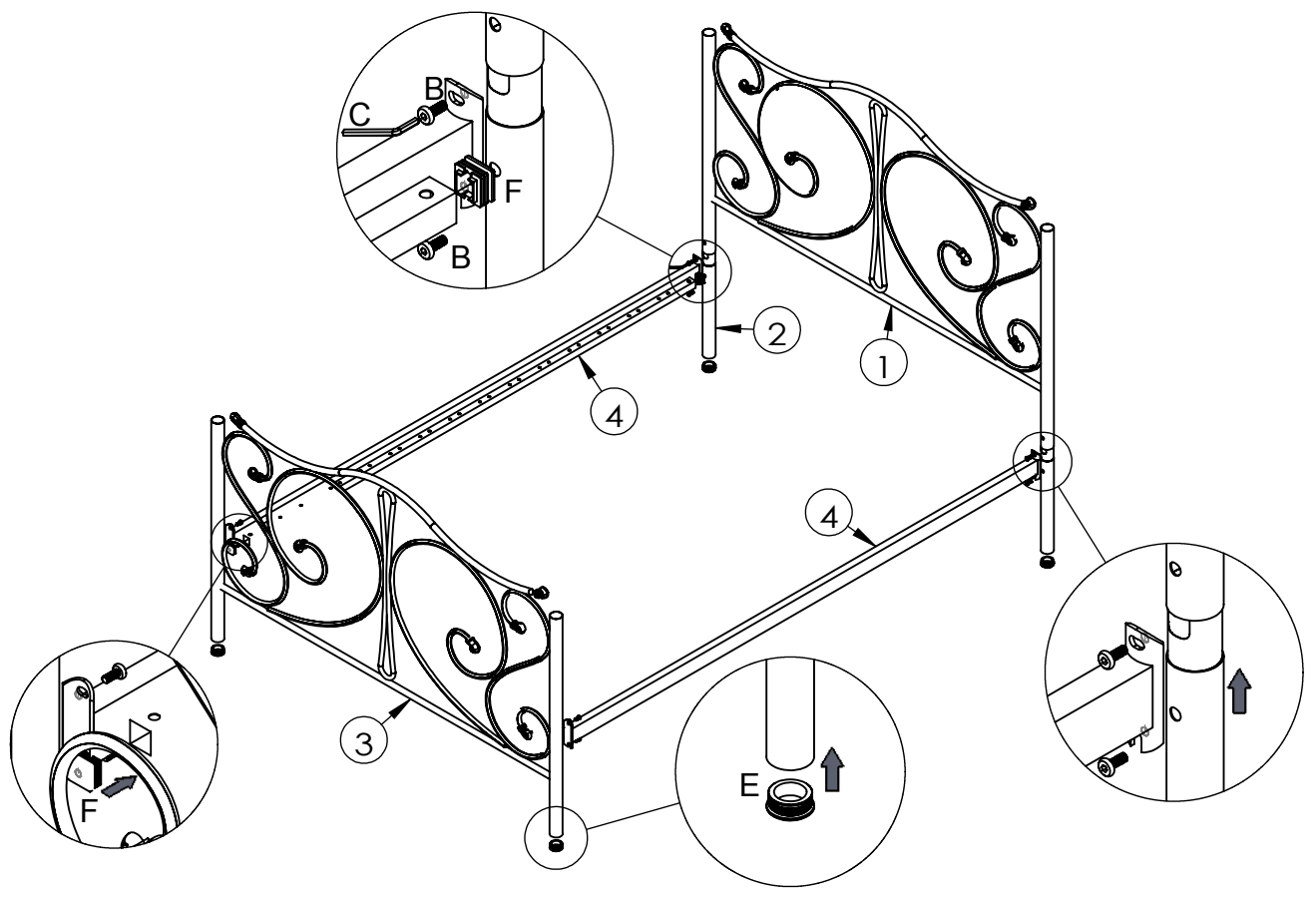

2

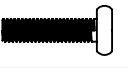

M6 x 25 6pcs

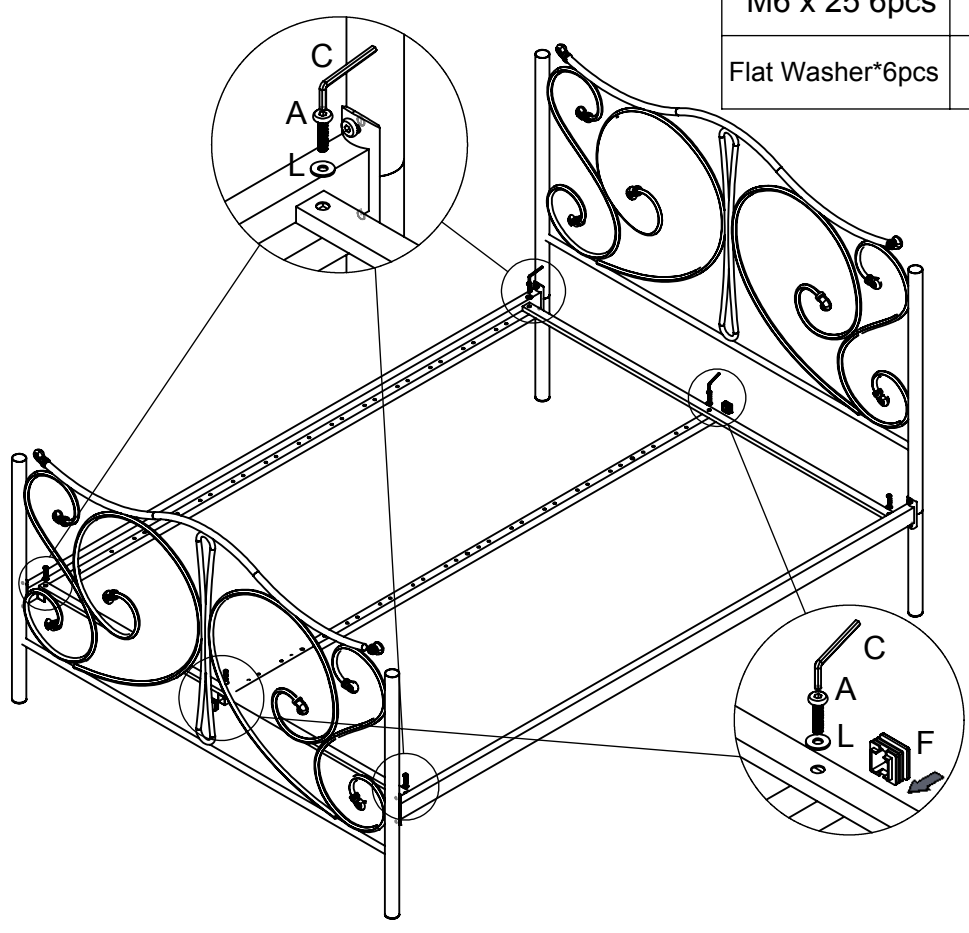

Flat Washer*6pcs



3

M6 x 15 3pcs	
Flat Washer*3pcs	

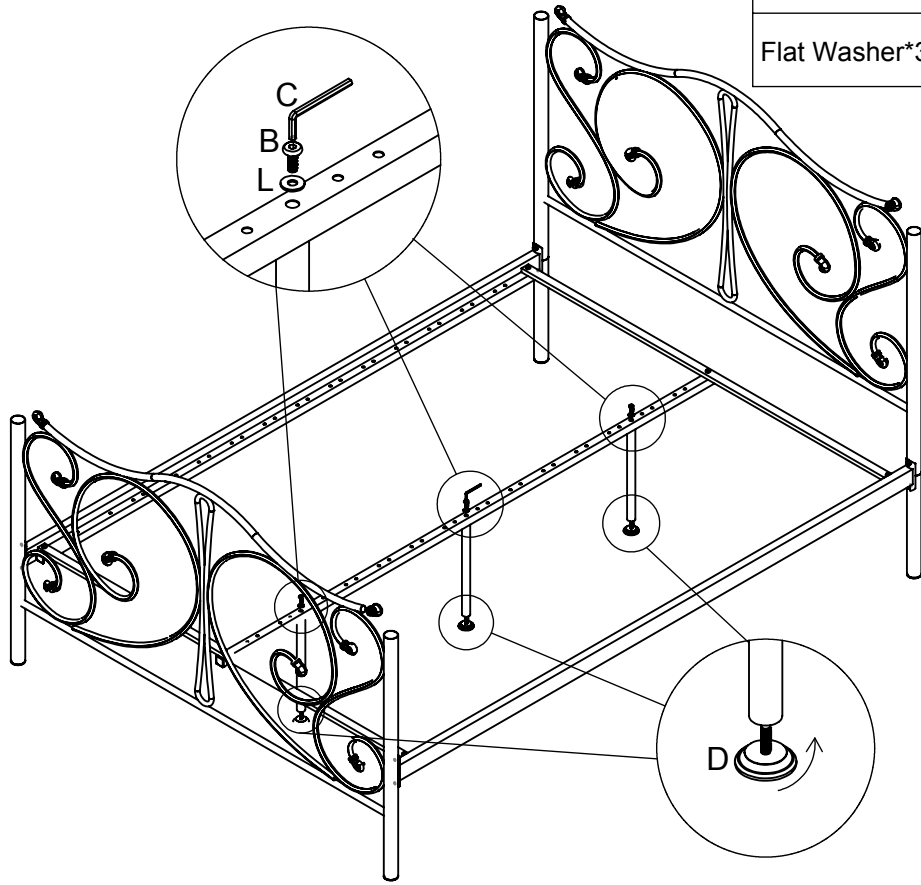

4

