

# LINDON DINING TABLE ASSEMBLY INSTRUCTIONS



**IMPORTANT  
FOR DOMESTIC USE ONLY  
PLEASE READ BEFORE YOU CONTINUE FURTHER**

THE PRODUCT YOU HAVE PURCHASED WILL GIVE YOU MANY YEARS OF SERVICE IF YOU FOLLOW THE GUIDELINES FOR ITS SAFE ASSEMBLY AND PERIODIC MAINTENANCE AND CLEANING .

ASSEMBLE ON A SOFT CLEAN SURFACE

DO NOT USE ANY TOOLS OTHER THAN THOSE SHOWN.

ANY SPANNERS OR ALLEN KEYS REQUIRED ARE INCLUDED WITH THE FITTINGS KIT.

DO NOT FOR ANY REASON USE A POWER TOOL TO ASSEMBLE THIS PRODUCT. ITS USE WILL INVALIDATE ANY CLAIM YOU MAY HAVE AND COULD MAKE THIS PRODUCT UNSAFE.

DEPENDING ON THE AMOUNT OF USE THIS PRODUCT RECEIVES IT MAY BE NECESSARY TO TIGHTEN UP THE FIXINGS FROM TIME TO TIME . THIS IS COMPLETELY NORMAL FOR ANY FLAT PACK FURNITURE.  
DO NOT OVERTIGHTEN FIXINGS.

FOR CLEANING, YOU MAY USE A DAMP CLOTH (NOT WET) DO NOT USE POLISH, DETERGENT OR CHEMICAL CLEANERS.

THIS PRODUCT MAY STAIN OR MARK IF ALLOWED TO COME INTO CONTACT WITH WET OR DAMP OBJECTS.

THE SURFACE OF THIS ITEM IS NOT HEAT RESISTANT. ALWAYS USE A PLACE MAT UNDER HOT OR COLD ITEMS TO PREVENT MARKING.

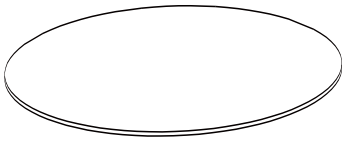

1

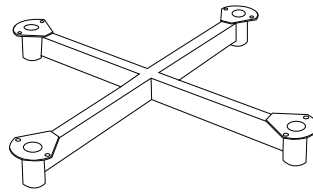

2









3

## PARTS LIST

Part Number	Part Code	Part Description	Quantity	Carton
1	S400-403-052-SF1-01	Table Top	1	1/1
2	S400-403-052-SF1-02	Support Bar	1	1/1
3	S400-403-052-SF1-03	Table Leg	4	1/1

## HARDWARE LIST

REF		HARDWARE NAME	QTY
A		Bolt M10x50mm	4PCS
B		Allen Key M8	1PC
C		Bolt M6x16mm	8PCS
D		Metal Washer M10x22	4PCS
E		Adjustable Foot	4PCS
F		Metal Washer M6x16	8PCS
G		Allen Key M5	1PC

PLEASE CHECK THAT YOU HAVE ALL THE PARTS LISTED BEFORE YOU START ASSEMBLING. IF YOU DO FIND THAT SOMETHING IS MISSING, DO NOT CONTINUE ASSEMBLY. PLEASE CONTACT YOUR SUPPLIER IMMEDIATELY.

# STEP 1

## PARTS REQUIRED

2 - SUPPORT BAR x1

3 - TABLE LEG x4

## HARDWARE REQUIRED

A  04

D  04

## TOOLS REQUIRED

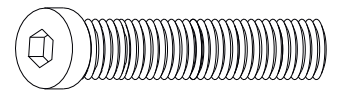

M10x50mm



M6x16mm

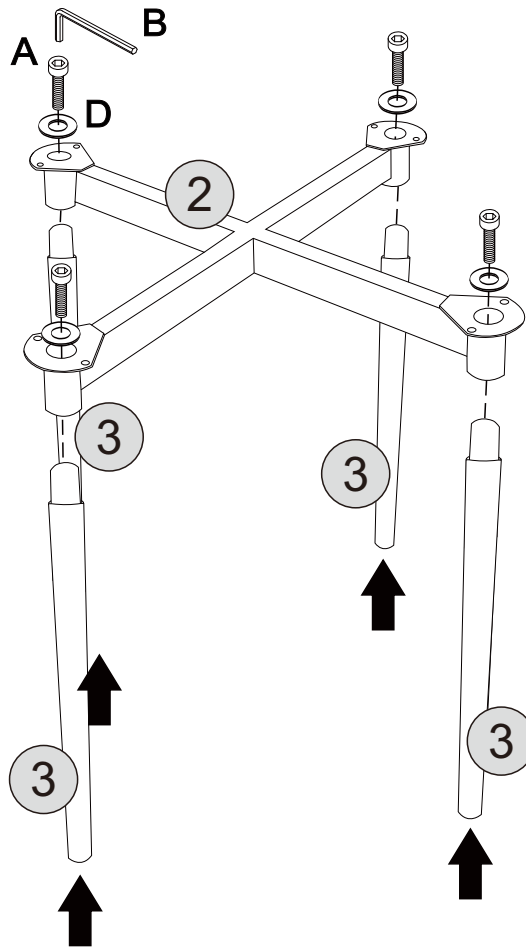

# STEP 2

## PARTS REQUIRED

1 - TABLE TOP x1

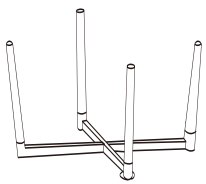

## HARDWARE REQUIRED

C  08

E  04

F  08

## TOOLS REQUIRED



M10x50mm

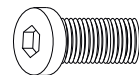

M6x16mm

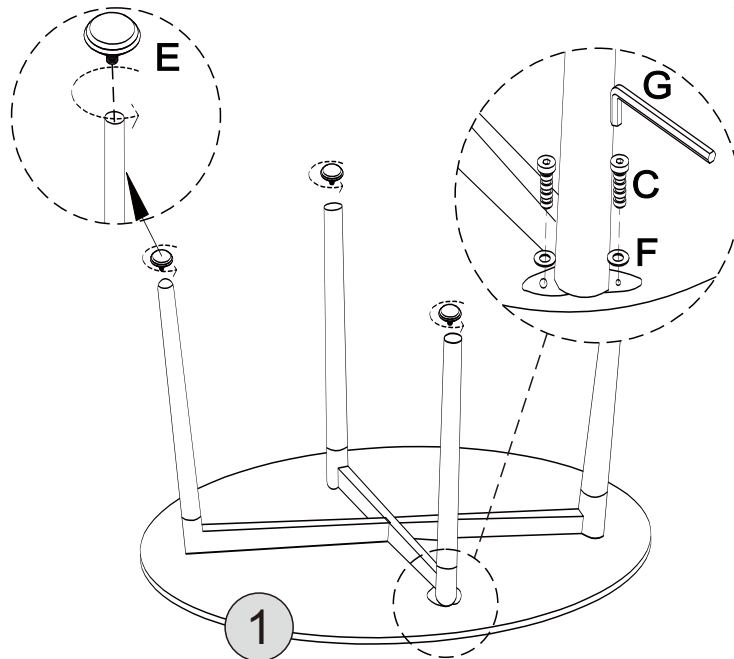

# LINDON DINING CHAIR ASSEMBLY INSTRUCTIONS



MAX CHAIR  
WEIGHT

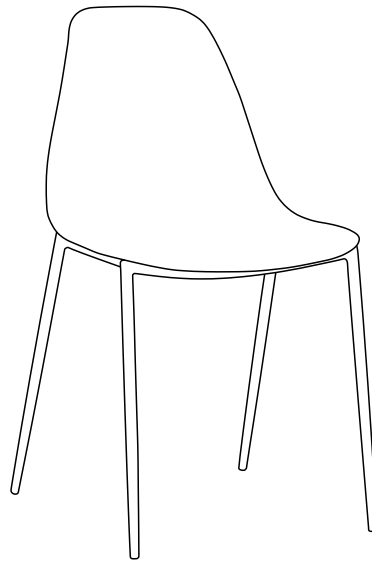

**IMPORTANT  
FOR DOMESTIC USE ONLY**

**PLEASE READ BEFORE YOU CONTINUE FURTHER**

THE PRODUCT YOU HAVE PURCHASED WILL GIVE YOU MANY YEARS OF SERVICE IF YOU FOLLOW THE GUIDELINES FOR ITS SAFE ASSEMBLY AND PERIODIC MAINTENANCE AND CLEANING .

ASSEMBLE ON A SOFT CLEAN SURFACE

DO NOT USE ANY TOOLS OTHER THAN THOSE SHOWN.

ANY SPANNERS OR ALLEN KEYS REQUIRED ARE INCLUDED WITH THE FITTINGS KIT.

DO NOT FOR ANY REASON USE A POWER TOOL TO ASSEMBLE THIS PRODUCT. ITS USE WILL INVALIDATE ANY CLAIM YOU MAY HAVE AND COULD MAKE THIS PRODUCT UNSAFE.

DEPENDING ON THE AMOUNT OF USE THIS PRODUCT RECEIVES IT MAY BE NECESSARY TO TIGHTEN UP THE FIXINGS FROM TIME TO TIME . THIS IS COMPLETELY NORMAL FOR ANY FLAT PACK FURNITURE.  
DO NOT OVERTIGHTEN FIXINGS.

FOR CLEANING, YOU MAY USE A DAMP CLOTH (NOT WET) DO NOT USE POLISH, DETERGENT OR CHEMICAL CLEANERS.

THIS PRODUCT MAY STAIN OR MARK IF ALLOWED TO COME INTO CONTACT WITH WET OR DAMP OBJECTS.

THE SURFACE OF THIS ITEM IS NOT HEAT RESISTANT. ALWAYS USE A PLACE MAT UNDER HOT OR COLD ITEMS TO PREVENT MARKING.

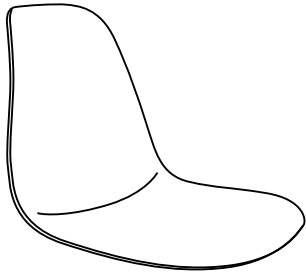

1

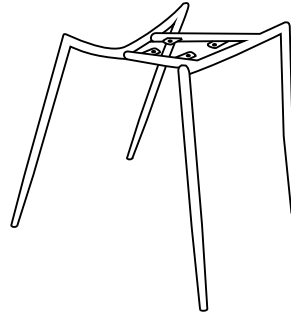



2

## **PARTS LIST**

<b>Part Number</b>	<b>Part Description</b>	<b>Quantity</b>	<b>Carton</b>
1	Chair Seat	1	1/1
2	Chair Leg	1	1/1

## **HARDWARE LIST**

REF	PART NAME		QTY
A		<b>Bolts M6x12mm</b>	4 PCS
B	 M6x18	<b>Metal Washer</b>	4 PCS
C	 M4	<b>Allen Key</b>	1 PC

**PLEASE CHECK THAT YOU HAVE ALL THE PARTS LISTED BEFORE YOU START ASSEMBLING. IF YOU DO FIND THAT SOMETHING IS MISSING, DO NOT CONTINUE ASSEMBLY. PLEASE CONTACT YOUR SUPPLIER IMMEDIATELY.**

# STEP 1

**PARTS REQUIRED**

1 - CHAIR SEAT x1

**HARDWARE REQUIRED**

**TOOLS REQUIRED**

Please remove the white plastic cap and keep the black washer before you start to assemble it, thanks.

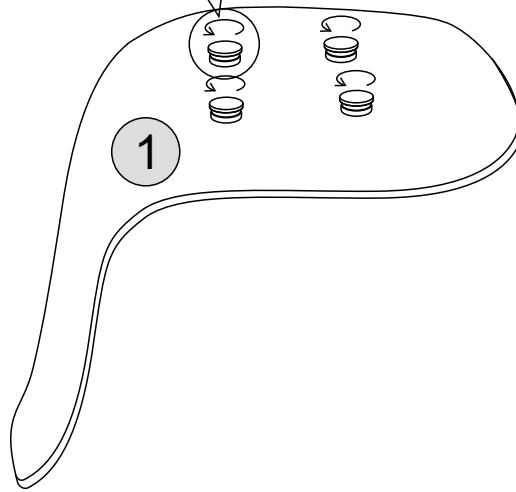

# STEP 2

**PARTS REQUIRED**

1 - CHAIR SEAT x1

2 - CHAIR LEG x1

**HARDWARE REQUIRED**

A  04

B  04

**TOOLS REQUIRED**

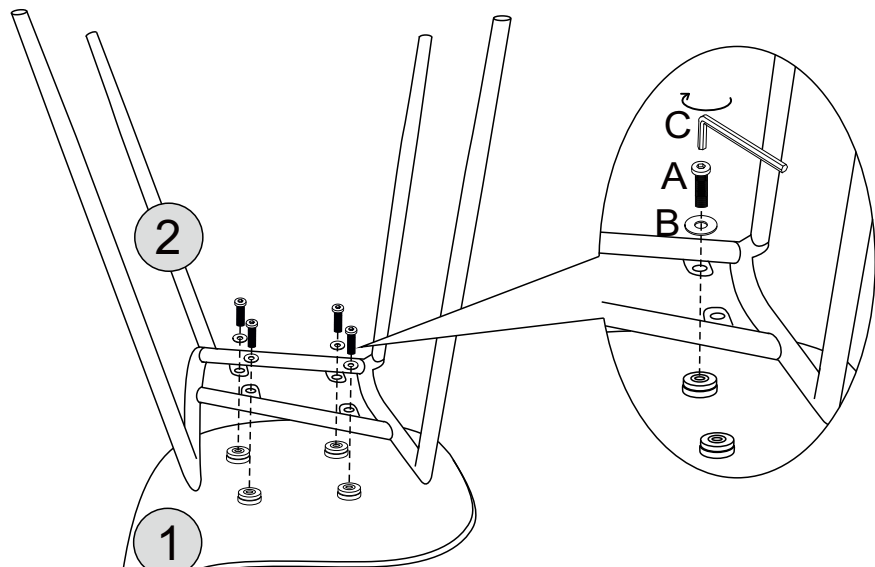

**100KG**  
MAX CHAIR WEIGHT

